

## Master Plan Numbers

	<b>Diamond Pro</b> Mira, Rua, Hue	<b>Diamond Pro</b> Synteen
<b>up to 6' / no surcharge / level backfill I</b>		
Soil Backfill	707-01-12	707-01-32
Rock Backfill		
<b>up to 6' / 120 PSF surcharge / level backfill</b>		
Soil Backfill	707-01-13	707-01-33
Rock Backfill		
<b>up to 6' / no surcharge / slope backfill</b>		
Soil Backfill	707-01-14	707-01-34
Rock Backfill		
<b>Double tier up to 4' (each) / level backfill</b>		
Soil Backfill	707-01-15	707-01-35
Rock Backfill		

Mira= Mirafi 3xt

Rau= Raugrid

Hue= Huesker

Distributed by:



[www.aspent.com](http://www.aspent.com)

(800) 869-9600

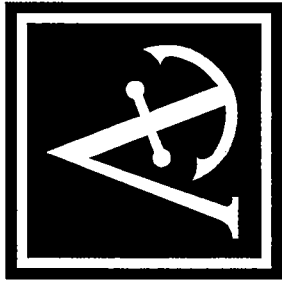

ANCHOR WALL SYSTEMS

ST. LOUIS COUNTY MASTERPLAN  
DIAMOND PRO WALLS  
SOIL REINFORCED ZONE

Index of Drawings

Sheet 1	Title and Index
Sheet 2	Applications and Design Information
Sheet 3, 4	Specifications
Sheet 5, 6, 7, 8	Typical Details
Sheet 9, 10	Standard Design - Horizontal Backfill
Sheet 11	Standard Design - Sloping Backfill
Sheet 12	Standard Design - Tiered Wall

**URS**



ANCHOR WALL SYSTEMS

BUILDING PRODUCTS CORPORATION  
950 Freeburg Avenue  
Belleville, Illinois 62220  
618-233-4427

COVER SHEET

Sheet 1 of 12

Date: July 22, 2002

# APPLICATION

The Anchor Diamond Pro Retaining Wall system is a reinforced soil structure combining an architecturally attractive concrete facing block with geogrid reinforcement. The geogrid reinforcement interlocks with the Anchor Diamond Pro block units and fill soil to create a stable gravity retaining wall. Design of these reinforced soil structures uses well established guidelines that are readily available. The following specifications and details provide a design to incorporate geogrid reinforcement into the soil for the purposes of constructing retaining walls. Consult Diamond Midwest for additional details regarding design, appearance, and aesthetic considerations.

## STANDARD DESIGN PROCEDURE

The following design tables established for the construction of soil reinforced walls are based upon generally accepted soil parameters in the St. Louis County, Missouri area. An engineer shall review the site conditions and the soil present at the proposed location of the soil reinforced walls to determine if the actual conditions match the assumed parameters. All soil parameters assumed in the design of the following tables are well drained, long term strength conditions. High plastic silts and clays should be avoided without specific design modification recommendations from an engineer. Frost heave and settlement need to be addressed if warranted by conditions. Consult an engineer if the walls are constantly in contact with water, i.e. near or at rivers, lakes and ponds.

Four typical geometric cases were selected for these tables. The first case is a typical retaining wall with horizontal backfill, the second case is with a 120 PSF Surcharge, the third case is a 3:1 sloping backfill, and the fourth case is a tiered wall. Global stability has not been checked. The following is a summary of the design parameters used and the minimum factors of safety which the tables are based on.

### SOIL PROPERTIES:

	Friction Angle (degrees)	Unit Weight (lbs./cf)	Cohesion (lbs./sf)
Wall Fill	28	120	0
Retained Backfill	28	120	0
Foundation Soil	28	120	0

Friction Angle - degrees  
Unit weight - lbs. per cf  
Cohesion - lbs. per sf

### MINIMUM FACTORS OF SAFETY (CALCULATED)

Reinforcement Pullout = 1.5  
Reinforcement Rupture = 1.5  
External Sliding = 1.5  
Overturning = 2.0  
Overall for Unknowns = 1.5  
Bearing Capacity = 2000 psf



ANCHOR WALL SYSTEMS

# APPLICATION

Sheet 2 of 12

Date: March 30, 2001

BUILDING PRODUCTS CORPORATION  
950 Freeburg Avenue  
Belleville, Illinois 62220  
618-233-4427

Section 02276

ANCHOR DIAMOND PRO RETAINING WALL SYSTEM

PART 1 GENERAL

1.01 SUMMARY

- A. Section Includes
1. Work includes furnishing and installing concrete segmental retaining wall units to the lines and grades designated on the construction drawings and as specified herein.
- B. Related Sections
1. Section - Geosynthetic Wall Reinforcement
  2. Section - Backfill Fill
  3. Section - Drainage Turf
  4. Section - Landscaping Turf
  5. Section - Drain Tile

1.02 REFERENCES

- A. American Society of Testing and Materials
1. ASTM C1372-91; Standard Specification for Segmental Retaining Wall Units.
  2. ASTM C 1282-95; Standard Test Method for Evaluating the Freeze-Thaw Durability of Manufactured Concrete Masonry Units and Related Concrete Units.
  3. ASTM C698-91; Standard Test Methods for Moisture-Density Relations of Soils and Soil-Aggregate Mixtures Using 5.5-lb Rammer and 12-in. Drop (Standard Proctor).
  4. ASTM D1557-91; Standard Test Methods for Moisture-Density Relations of Soils and Soil-Aggregate Mixtures Using 10-lb Rammer and 18-in. Drop (Modified Proctor).
  5. ASTM D448-86; Standard Classification for Sizes of Aggregate for Road and Bridge Construction.
  6. ASTM C 140-96; Standard Test Methods of Sampling and Testing Concrete Masonry Units.
  7. ASTM D 2922-91; Standard Test Method for Density of Soil and Soil-Aggregate in Place by Nuclear Methods (Shallow Depth).
  8. ASTM D 1556-90; Standard Test Method for Density of Soil in Place by the Sand Cone Method.
  9. ASTM D 2488 Standard Practice for Description and Identification of Soils. Visual-Manual Procedure (USCS; Unified Soil Classification System).

1.03 SUBMITTALS

- A. Submit the following in accordance with Section 01300:
1. Manufacturer's literature: Materials description
  2. Shop drawings: Retaining wall system design, including wall heights, geosynthetic reinforcement layout and drainage provisions. The shop drawings shall be signed by a registered professional engineer licensed in the state of wall installation.
  3. Samples
    - a) Furnish one (1) unit in the color and face pattern specified if requested by the Architect. If approved, unit may be used in the finished work.
    - b) 12 inches square or larger piece of the geosynthetic reinforcement specified.
  4. Test reports from an independent laboratory stating moisture absorption and compressive strength properties of the concrete wall units meet the project specifications when tested in accordance with ASTM C 140-96. Sections 6, 8 and 9.

1.04 DELIVERY, STORAGE AND HANDLING

- A. The Contractor shall check the materials upon delivery to assure that proper material has been received.

- B. Deliver and handle materials in such manner as to prevent damage. Store above ground on wood pallets or blocking. Remove damaged or otherwise unsuitable material, when so determined, from the site.

1. Faces of the concrete wall units shall be substantially free of chips, cracks and stains.
2. The Contractor shall prevent excessive mud, wet cement, epoxy and like material, which may affix themselves, from coming in contact with the material.

1.05 EXTRA MATERIALS

- A. Furnish Owner with three (3) replacement units identical to those installed on the Project.

1.06 DEFINITIONS

- A. Geosynthetic reinforcement is a material specifically fabricated for use as a soil reinforcement.
- B. Concrete retaining wall units are as detailed on the drawings and are specified under Section 02276; Anchor Diamond Retaining Wall Units.
- C. Drainage aggregate is a material used around and directly behind the concrete wall units.
- D. Backfill is the soil which is used as fill behind the drainage aggregate, and within the reinforced soil mass if applicable.
- E. Foundation soil is the soil mass supporting the leveling pad and reinforced zone of the retaining wall system.

1.07 DISCREPANCIES

- A. Should discrepancies exist between the plans and specifications, the plan shall take precedence over the specifications.

PART 2 PRODUCTS

2.01 MATERIALS

- A. Concrete Retaining Wall Unit: "Anchor Diamond Pro Retaining Wall Units" as manufactured under license from Anchor Wall Systems.
1. Concrete wall units shall meet requirements of ASTM C1372-91 except the maximum water absorption shall be limited to 7.0 percent and unit height dimensions shall not vary more than +/- 1/16 inch from that specified.
  2. Concrete wall units are required to have a minimum of 0.67 square foot face area.
  3. Color as selected by Architect from manufacturer's standard selections.
  4. Face pattern: Geometry: Beveled or Straight.
  5. Texture: Smooth or Split Rock Face.
  6. The concrete units shall include an integral concrete shear connection flange/locator.
- B. Geosynthetic reinforcement: Polyester fiber geogrid, polyethylene expanded sheet geogrid, or polypropylene woven geotextile for use as soil reinforcement.
- C. Base: Material shall consist of drainage aggregate, sand and gravel and/or concrete as shown on the construction drawings. A minimum of 6 inches of compacted base is required.
- D. Drainage aggregate: Fill between units shall consist of free-draining, crushed coarse aggregate that meets the gradation requirements of ASTM 448-86; Standard Classification for Sizes of Aggregate for Road and Bridge Construction, designation 57, 67, 6, 7 or 8.
- E. Backfill: Materials are suitable non-organic soils at a moisture content which enables compaction to the specified densities. Unsuitable soils are organic soils and those soils with the USCS classification symbol of CH, OH, MH, OL or PT. CL soils with a Plasticity Index (PI) greater than 25 are also considered unsuitable soils.
- F. Drain tile: The drainage collection pipe shall be a perforated or slotted PVC or corrugated HDPE pipe. The pipe may be covered with a geotextile filter fabric to function as a filter.



ANCHOR WALL SYSTEMS

BUILDING PRODUCTS CORPORATION  
950 Freeburg Avenue  
Belleville, Illinois 62220  
618-233-4427

SPECIFICATIONS

Sheet 3 of 12

Date: March 30, 2001

**PART 3 EXECUTION**

**3.01 EXAMINATION**

A. The contractor shall examine the areas and conditions under which the retaining walls to be erected and notify the Architect or Civil Engineer in writing of conditions detrimental to the proper and timely completion of the work. Do not proceed with the work until unsatisfactory conditions have been corrected. The contractor shall promptly notify the wall design engineer of any site conditions which may affect wall performance or may require a reevaluation of the wall design.

**3.02 EXCAVATION**

A. The Contractor shall excavate to the lines and grades shown on the construction drawings. Over-excavation not approved by the owner or duly appointed owner's representative shall not be paid for and replacement with compacted fill and/or wall system components will be required at the Contractor's expense. The Contractor shall be careful not to disturb base beyond the lines shown. The Contractor shall be responsible for the stability of the excavation and its influence on adjacent properties and structures.

**3.03 FOUNDATION PREPARATION**

A. Foundation soil shall be excavated as required for footing or base dimension shown on the construction drawings, or as directed by the Engineer.  
B. Foundation soil shall be examined by the project geotechnical engineer to ensure that the actual foundation soil strength meets or exceeds that required on the construction drawings. Soil not meeting the required strength shall be removed, sufficiently oversized from the front of the block and the back of the reinforcement and backfilled with suitable material.  
C. Over-excavated areas shall be filled with suitable compacted backfill.

**3.04 BASE COURSE PREPARATION**

A. Base materials shall be placed as shown on the construction drawings with a minimum thickness of 6 inches.  
B. Base materials shall be installed upon undisturbed soils, or foundation soils prepared in accordance with Section 3.03.  
C. Material shall be compacted so as to provide a level, hard surface on which to place the first course of units.  
D. Base materials shall be prepared to ensure complete contact of retaining wall unit. Gaps shall not be allowed.  
E. Base materials shall be to the depths and widths shown on the plans. The Contractor may opt for using reduced depth of sand and gravel and replacement with a 1" to 2" concrete topping. Concrete shall be lean, unreinforced and a maximum of two inches thick. Where a reinforced footing is required, place below the frost line.

**3.05 ERECTION**

A. Erect units as specified herein.  
B. First course of concrete wall units shall be placed on the prepared base material. Units shall be checked for level and alignment. The top of all units in base course shall be at the same elevation.  
C. Ensure that concrete wall units are in full contact with base.  
D. Concrete wall units shall be placed side by side for full length of wall alignment. Alignment may be done by using a string line or offset of wall line.  
E. Fill all voids between and within concrete wall units with drainage aggregate.  
F. A minimum of 12 inches of drainage aggregate shall be placed behind the concrete wall units.  
G. Drain tile shall be installed at the lowest elevation possible to maintain gravity flow of water to outside of the reinforced zone. The drainage collection pipe shall be daylighted to an appropriate location away from the wall system at each low point or at 50 foot intervals along the wall.  
H. Remove all excess fill from top of units and install next course. Ensure drainage aggregate and backfill are compacted before installation of next course.

I. Install each succeeding course. Backfill as each course is completed. Pull the units forward until the locating surface of the unit contacts the locating surface of the units in the preceding course. Pull the units forward as far as possible.

J. Install geosynthetic reinforcement in accordance with geosynthetic manufacturer's recommendations and the design drawings.

**3.06 BACKFILL PLACEMENT**

A. Reinforced backfill shall be placed, spread and compacted in a manner that will minimize slack in the reinforcement.  
B. Fill in the reinforced zone shall be placed and compacted in lifts not to exceed 6 to 8 inches (loose thickness) where hand-operated compaction equipment is used and not exceeding 12 inches (loose thickness) where heavy, self-applied compaction equipment is used.  
C. All filled compaction equipment is used. Recommended by the project geotechnical engineer. (ASTM D 698-91) or as recommended by the soil's standard Proctor density.  
D. Only lightweight hand-operated equipment shall be allowed within 4 feet of the back of the retaining wall units, or one-half of the wall height, whichever is greater.

**3.07 CAP UNIT INSTALLATION (If Applicable)**

A. Apply construction adhesive to the top surface of the unit below and place the cap unit into desired position.  
B. Cap units may need to be cut to obtain the proper fit.  
C. Backfill and compact to finish grade.

**3.08 ADJUSTING AND CLEANING**

A. Damaged units should be replaced with new units during construction.  
B. Contractor shall remove debris caused by wall construction and leave adjacent paved areas broom clean.

**3.09 Quality Control**

A. The wall installation contractor is responsible for quality control of installation of all materials. The contractor should enlist the assistance of a qualified independent third party to verify the correct installation of all materials according to these specifications and the construction drawings.  
B. The owner, at his own expense, should retain a qualified professional to perform random quality assurance checks of the contractor's work.  
C. Work found to be deficient according to these specifications or the construction drawings must be corrected at the contractor's expense.  
D. The retaining wall will not be considered complete until accepted by the engineer or duly appointed owner's representative.

**3.10 Measurement and Payment**

A. Measurement of segmental retaining wall shall be on an installed square foot basis computed on the total face area of wall installed. Wall face area is taken from the bottom of the base course to the top of the wall.  
B. Payment for the wall will be made on a square foot basis at the contract unit price.  
1. Payment should be considered full compensation for all labor, materials, equipment and testing required to install the wall in accordance with these specifications and the construction drawings.  
2. Quantities may vary from that shown on the construction drawings depending on existing topography. Change to the total quantity of wall face area will be paid or withheld at the contract unit bid price.



**ANCHOR WALL SYSTEMS**

**BUILDING PRODUCTS CORPORATION**  
950 Freeburg Avenue  
Belleville, Illinois 62220  
618-233-4427

**SPECIFICATIONS**

Sheet 4 of 12

Date: March 30, 2001

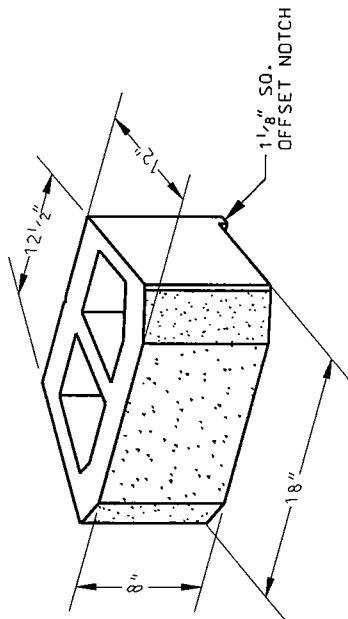

### BLOCK DETAIL

NOT TO SCALE

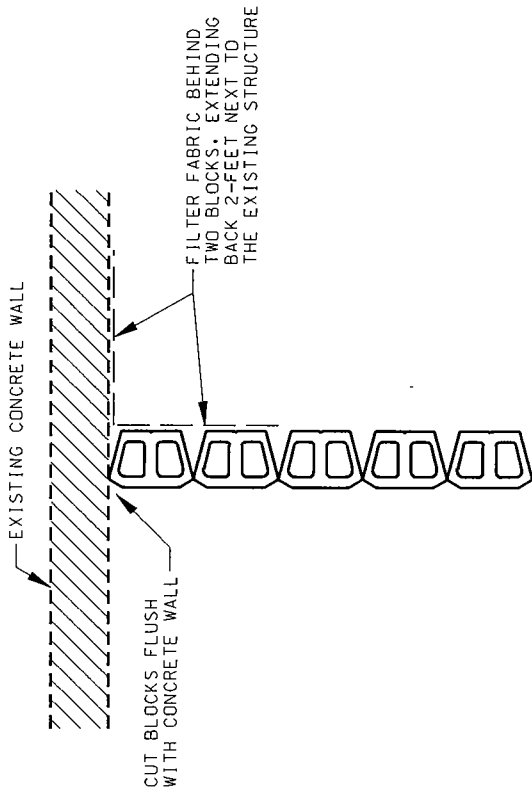

### ABUTMENT DETAIL

NOT TO SCALE



ANCHOR WALL SYSTEMS

BUILDING PRODUCTS CORPORATION  
 950 Freeburg Avenue  
 Belleville, Illinois 62220  
 618-233-4427

### DETAILS

Sheet 5 of 12

Date: September 27, 2004

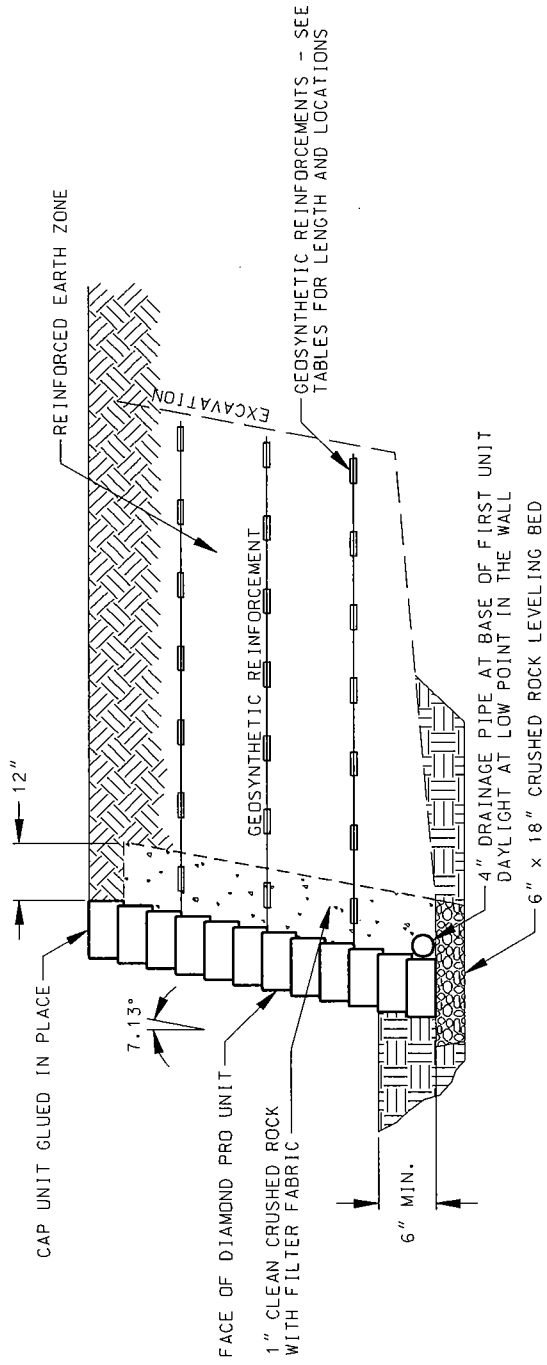

TYPICAL SECTION - WITH REINFORCEMENT

NOT TO SCALE

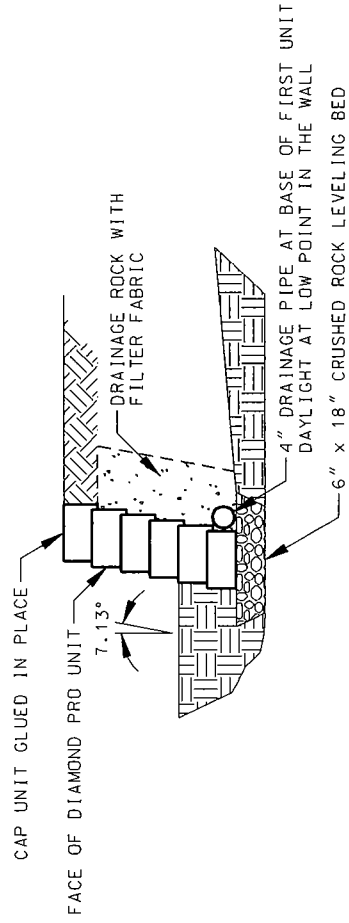

TYPICAL SECTION - WITHOUT REINFORCEMENT

NOT TO SCALE



ANCHOR WALL SYSTEMS

BUILDING PRODUCTS CORPORATION  
 950 Freeburg Avenue  
 Belleville, Illinois 62220  
 618-233-4427

TYPICAL SECTIONS

Sheet 6 of 12

Date: July 22, 2002

2" TO 3" OF SOIL FILL REQUIRED BETWEEN OVERLAPPED REINFORCEMENT FOR PROPER SOIL AND REINFORCEMENT INTERACTION

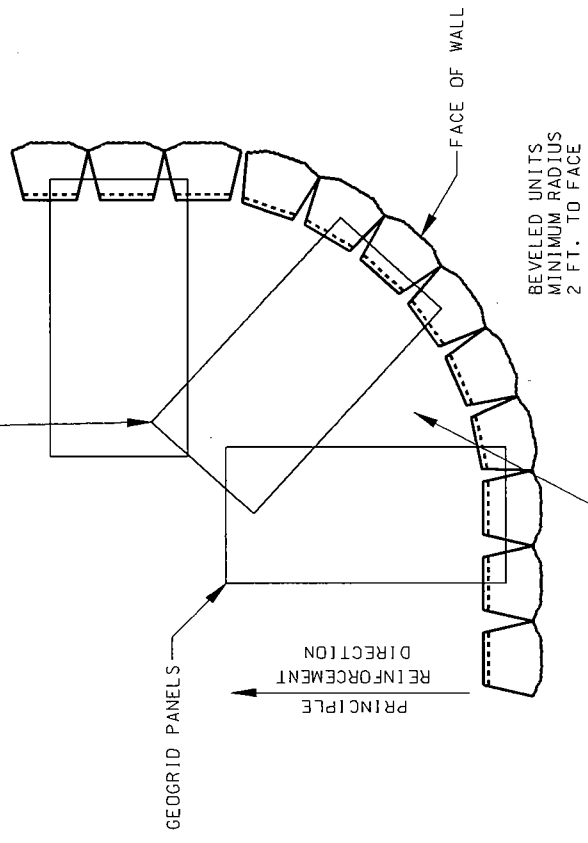

PLACE ADDITIONAL REINFORCEMENT ON THE NEXT COURSE OF SEGMENTAL UNITS IMMEDIATELY ABOVE THE SPECIFIED PLACEMENT ELEVATION IN A MANNER THAT ELIMINATES GAPS LEFT BY THE PREVIOUS LAYER OF GEOSYNTHETIC AT THE SPECIFIED REINFORCEMENT ELEVATION.

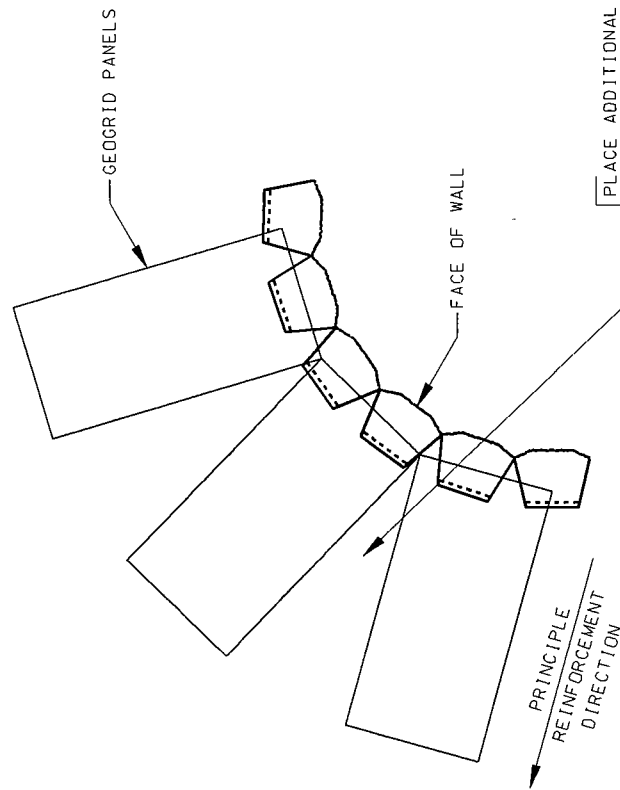

OUTSIDE CORNER DETAIL

NOT TO SCALE

INSIDE CORNER DETAIL

NOT TO SCALE

DETAILS

Sheet 7 of 12

Date: September 27, 2004

BUILDING PRODUCTS CORPORATION  
950 Freeburg Avenue  
Belleville, Illinois 62220  
618-233-4427



ANCHOR WALL SYSTEMS



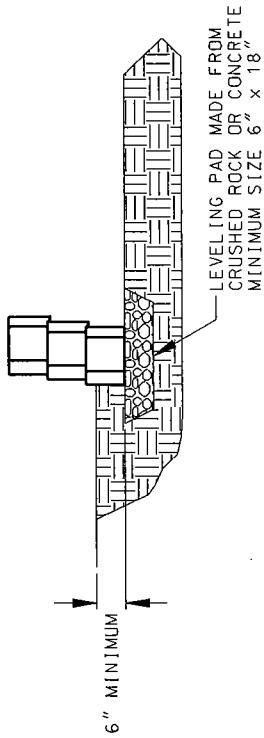

LEVELING PAD MADE FROM  
CRUSHED ROCK OR CONCRETE  
MINIMUM SIZE 6" x 18"

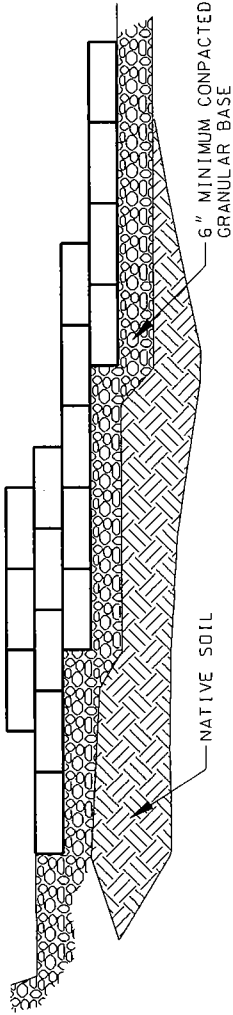

### LEVELING PAD DETAIL

NOT TO SCALE

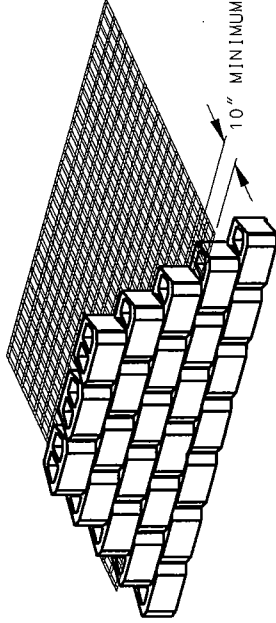

10" MINIMUM



REINFORCEMENT LENGTH

10" MINIMUM

PULL OUT SLACK IN REINFORCEMENT

### CONNECTION DETAIL

NOT TO SCALE



ANCHOR WALL SYSTEMS

BUILDING PRODUCTS CORPORATION  
950 Freeburg Avenue  
Belleville, Illinois 62220  
618-233-4427

### DETAILS

Sheet 8 of 12

Date: September 27, 2004

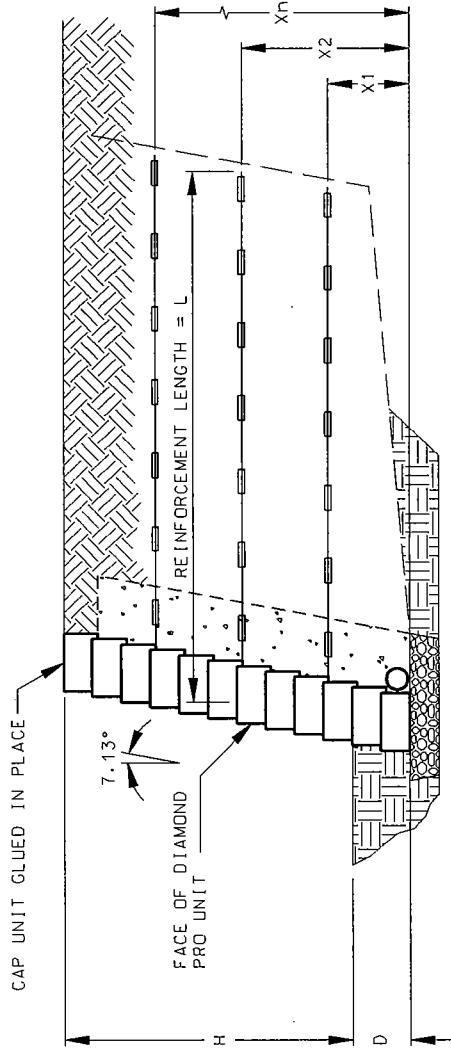

## TYPICAL SECTION

NOT TO SCALE

**DESIGN TABLE**

Exposed Wall Height H	Depth Below Grade D	Total No. Courses For Finished Wall	Length L	Geosynthetic reinforcement Placement Distance Up From Wall Base In Ft.						
				X1	X2	X3	X4	X5	X6	
2'-2"	6"	4	3'-6"	1'-4"						
3'-6"	6"	6	4'-6"	2'-0"						
5'-6"	6"	9	5'-0"	2'-0"	4'-0"					

All geogrids are to be Synteen SF35 of Synteen SF55



ANCHOR WALL SYSTEMS

BUILDING PRODUCTS CORPORATION  
950 Freeburg Avenue  
Belleville, Illinois 62220  
618-233-4427

HORIZONTAL GRADE

Sheet 9 of 12

Date: July 22, 2002

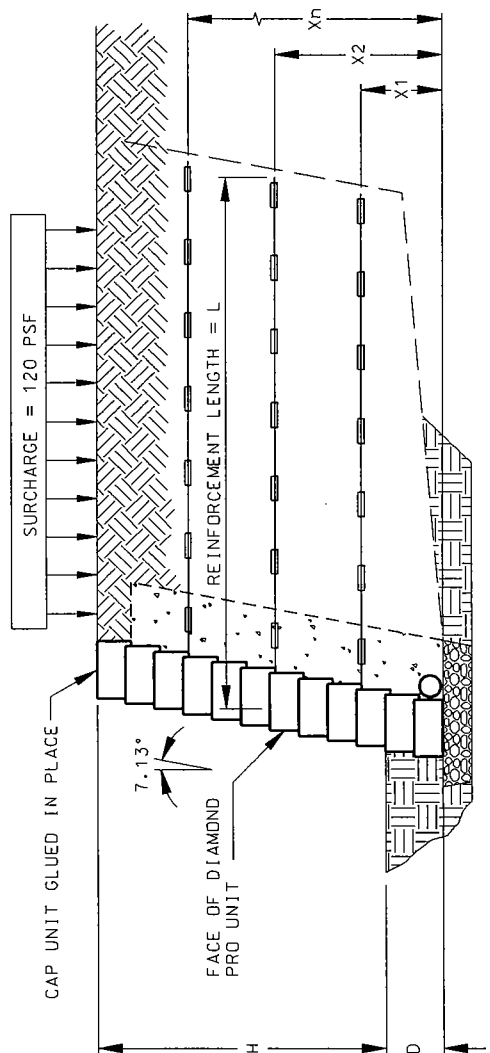

**TYPICAL SECTION**  
NOT TO SCALE

**DESIGN TABLE**

Exposed Wall Height H	Depth Below Grade D	Total No. Courses For Finished Wall	Length L	Geosynthetic reinforcement Placement Distance Up From Wall Base In Ft.						
				X1	X2	X3	X4	X5	X6	
2'-2"	6"	4	4'-6"	0'-8"	2'-0"					
3'-6"	6"	6	5'-0"	0'-8"	2'-8"					
5'-6"	6"	9	6'-6"	0'-8"	2'-8"	4'-8"				

All geogrids are to be Synteen SF35 of Synteen SF55



ANCHOR WALL SYSTEMS

BUILDING PRODUCTS CORPORATION  
950 Freeburg Avenue  
Belleville, Illinois 62220  
618-233-4427

HORIZONTAL GRADE

Sheet 10 of 12

Date: July 22, 2002

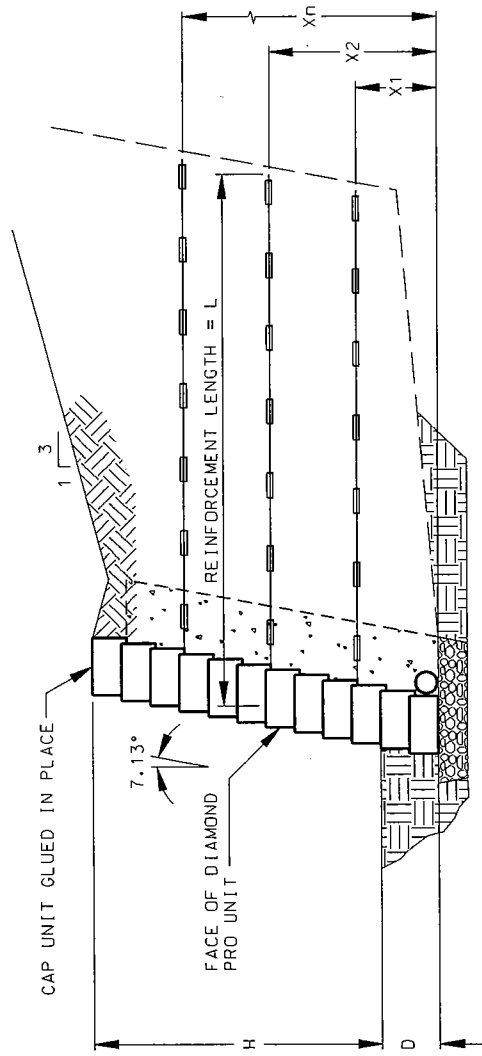

## TYPICAL SECTION

NOT TO SCALE

### DESIGN TABLE

Exposed Wall Height	Depth Below Grade	Total No. Courses For Finished Wall	Length	Geosynthetic reinforcement Placement Distance Up From Wall Base In Ft.						
				X1	X2	X3	X4	X5	X6	
2'-2"	6"	4	3'-6"	1'-4"						
3'-6"	6"	6	5'-0"	2'-0"						
5'-6"	6"	9	5'-6"	2'-0"	4'-0"					

All geogrids are to be Synteen SF35 of Synteen SF55



ANCHOR WALL SYSTEMS

BUILDING PRODUCTS CORPORATION  
950 Freeburg Avenue  
Belleville, Illinois 62220  
618-233-4427

SLOPING GRADE

Sheet 11 of 12

Date: July 22, 2002

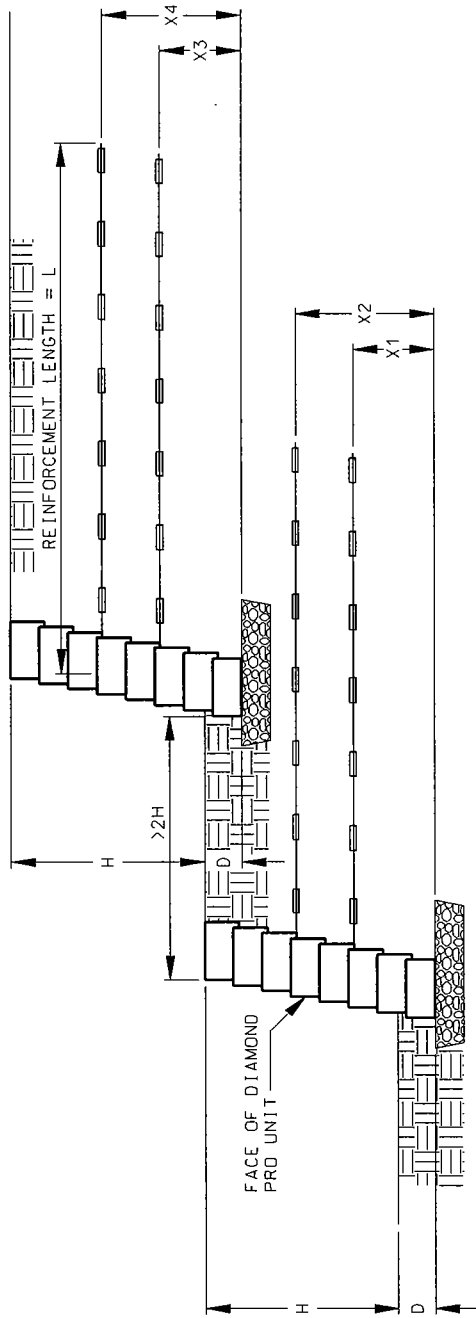

### TYPICAL SECTION

NOT TO SCALE

DESIGN TABLE

Exposed Wall Height H	Depth Below Grade D	Total No. Courses For Finished Wall L	Length	Geosynthetic reinforcement Placement Distance Up From Wall Base In Ft.						
				X1	X2	X3	X4	X5	X6	
2'-2"	6"	4	3'-6"	1'-4"						
3'-6"	6"	6	4'-6"	2'-0"		1'-4"				
				2'-0"		2'-0"				

All geogrids are to be Synteen SF35 of Synteen SF55



ANCHOR WALL SYSTEMS

BUILDING PRODUCTS CORPORATION  
950 Freeburg Avenue  
Belleville, Illinois 62220  
618-233-4427

TIERED WALL

Sheet 12 of 12

Date: March 30, 2001

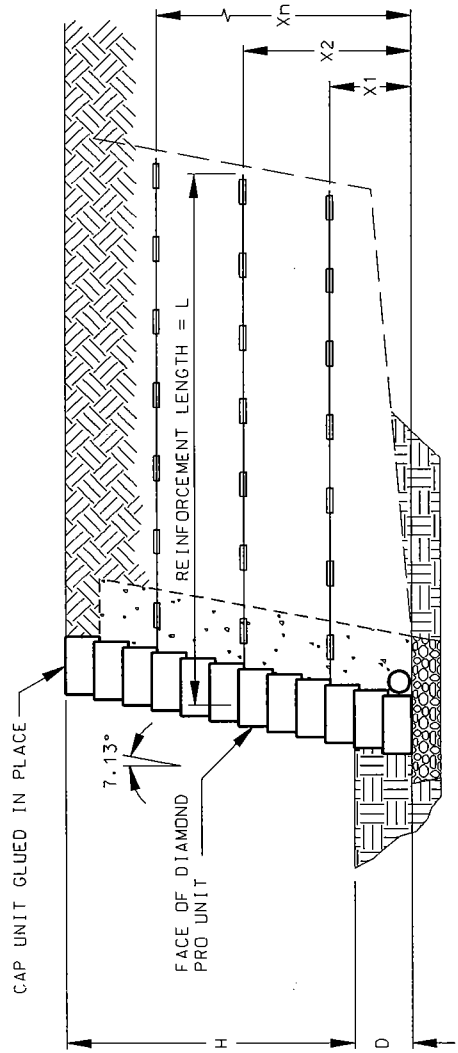

### TYPICAL SECTION

NOT TO SCALE

DESIGN TABLE

Exposed Wall Height H	Depth Below Grade D	Total No. Courses For Finished Wall	Length L	Geosynthetic reinforcement Placement Distance Up From Wall Base In Ft.						
				X1	X2	X3	X4	X5	X6	
2'-2"	6"	4	3'-6"	1'-4"						
3'-6"	6"	6	4'-6"	2'-0"						
5'-6"	6"	9	5'-0"	2'-0"	4'-0"					

All geogrids are to be Mirafi 3XT, Huesker 35/20-20, Raugrid 3/3-20, or Stratagrid 200



ANCHOR WALL SYSTEMS

BUILDING PRODUCTS CORPORATION  
950 Freeburg Avenue  
Belleville, Illinois 62220  
618-233-4427

HORIZONTAL GRADE

Sheet 9 of 12

Date: July 22, 2002

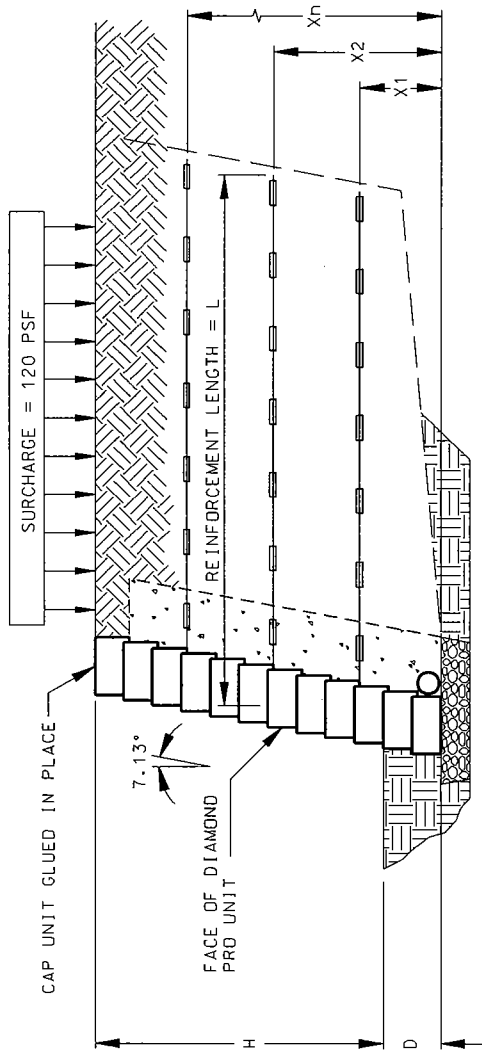

TYPICAL SECTION

NOT TO SCALE

DESIGN TABLE

Exposed Wall Height H	Depth Below Grade D	Total No. Courses For Finished Wall	Length L	Geosynthetic reinforcement Placement Distance Up From Wall Base In Ft.						
				X1	X2	X3	X4	X5	X6	
2'-2"	6"	4	4'-6"	0'-8"	2'-0"					
3'-6"	6"	6	5'-0"	0'-8"	2'-8"					
5'-6"	6"	9	6'-6"	0'-8"	2'-8"	4'-8"				

All geogrids are to be Mirafi 3XT, Huesker 35/20-20, Raugrid 3/3-20, or Stratagrid 200



ANCHOR WALL SYSTEMS

HORIZONTAL GRADE

Sheet 10 of 12

Date: July 22, 2002

BUILDING PRODUCTS CORPORATION  
950 Freeburg Avenue  
Belleville, Illinois 62220  
618-233-4427

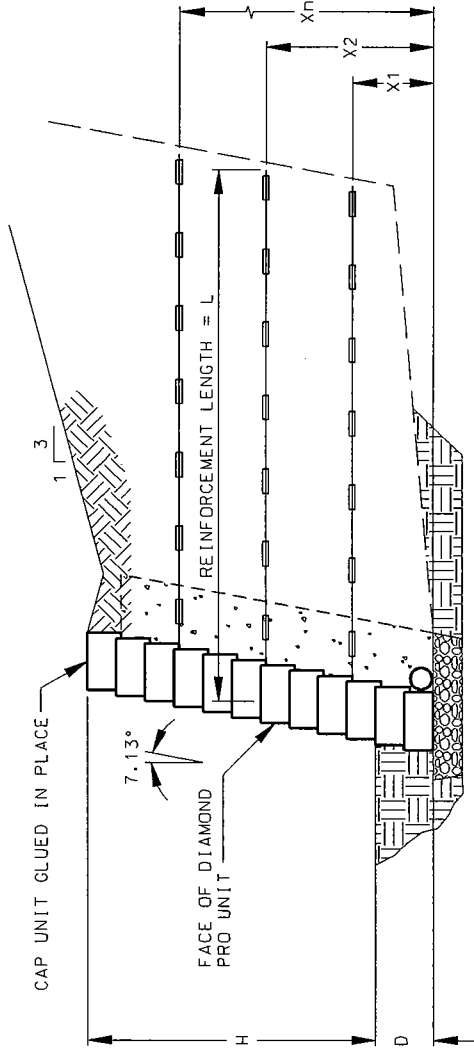

### TYPICAL SECTION

NOT TO SCALE

DESIGN TABLE

Exposed Wall Height H	Depth Below Grade D	Total No. Courses For Finished Wall	Length L	Geosynthetic reinforcement Placement Distance Up From Wall Base In Ft.						
				X1	X2	X3	X4	X5	X6	
2'-2"	6"	4	3'-6"	1'-4"						
3'-6"	6"	6	5'-0"	0'-8"	2'-8"					
5'-6"	6"	9	5'-6"	0'-8"	2'-8"	4'-8"				

All geogrids are to be Mirafra 3XT, Huesker 35/20-20, Raugrid 3/3-20, or Stratagrid 200



ANCHOR WALL SYSTEMS

SLOPING GRADE

Sheet 11 of 12

Date: July 22, 2002

BUILDING PRODUCTS CORPORATION  
 950 Freeburg Avenue  
 Belleville, Illinois 62220  
 618-233-4427



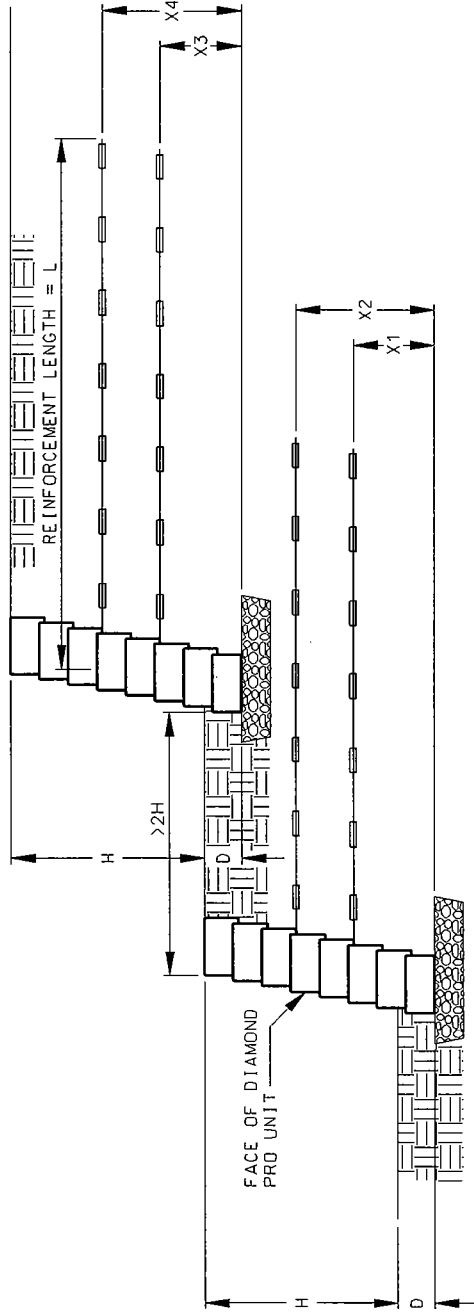

### TYPICAL SECTION

NOT TO SCALE

DESIGN TABLE

Exposed Wall Height H	Depth Below Grade D	Total No. Courses For Finished Wall	Length L	Geosynthetic reinforcement Placement Distance Up From Wall Base In Ft.						
				X1	X2	X3	X4	X5	X6	
2'-2"	6"	4	4'-0"	1'-4"						
3'-6"	6"	6	5'-0"	2'-0"		1'-4"				

All geogrids are to be Mirafra 3XT, Huesker 35/20-20, Raugrid 3/3-20, or Stratagrid 200



ANCHOR WALL SYSTEMS

TIERED WALL

Sheet 12 of 12

Date: March 30, 2001

BUILDING PRODUCTS CORPORATION  
950 Freeburg Avenue  
Belleville, Illinois 62220  
618-233-4427